

4000

SERIES



EUROCAVE
PROFESSIONAL

EuroCave Professional is the world leader in storing and serving wine for hotels, restaurants, wine merchants and vineyards: our long-term partners.

All the brand's products combine recognized technical expertise and ergonomics specifically optimized for professionals.

EuroCave Professional,
the difference.



Make
the difference.

Turn your wine list into
a real asset.

Guarantee your customers an optimal wine tasting experience by always having your wine ready at an ideal serving temperature.

With its modularity, advanced technology and attractive design, the 4000 series has the same great EuroCave features, recognized and appreciated all over the world.

4000
series



Storing *Serving*

Available as a maturing or multi-temperature cabinet, the 4000 series provides an ideal storage or serving temperature to satisfy even your most discerning customers.

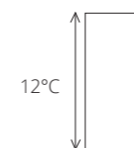

Maturing / single-temperature

Temperature can be set from 6 - 18°C
Default temperature setting 12°C

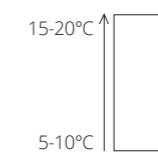

Serving / multi-temperature

Temperature can be set from 5 - 20°C
5-10°C for the bottom
15-20°C for the top
Default temperature setting 8-18°C

An invitation to taste

The 4000 series offers many layout possibilities to most effectively meet your storage and serving requirements. Your bottles are also perfectly showcased to promote your wine list.



Black aluminium labels* to identify your bottles.

Glass or solid door, with black frame. Stainless steel handle.

White lighting for bottles. Shelf with horizontal display.

* Labels and white marker pen available as an optional extra

Layouts*

Premium pack

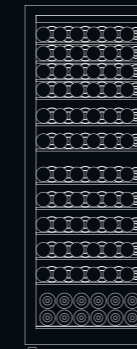

11 x sliding

146 bottles**



11 x sliding
Horizontal display

131 bottles

Access pack

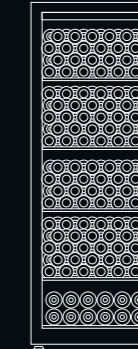

4 x storage

230 bouteilles

Customisable (example)



13 x sliding
(2 additional shelves available as an optional extra)

170 bottles

Shelf

The multi-purpose shelf is designed to hold all types of bottles. Fixed or sliding shelves - You decide. Stack them, arrange them horizontally or vertically, according to your preference.

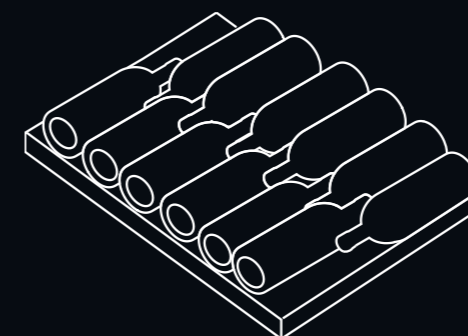

Sliding
Up to 12 bottles



Storage
Up to 77 bottles



Vertical display
Up to 28 bottles



Horizontal display
Up to 9 bottles



Horizontal display
Up to 7 bottles

*Capacity stated for "traditional Bordeaux" bottles

**130 bottles in champagne + "traditional Bordeaux"

Every detail,
carefully crafted.



Quality

Every detail is a testament to EuroCave Professional's excellence.

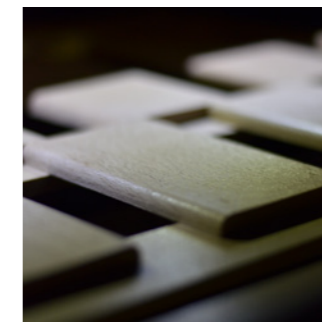
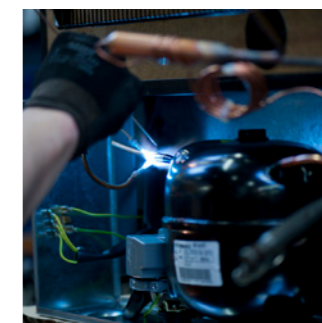

Durable, high-quality materials

Structure of cabinet body in reinforced metal, shelf in beech wood, very hard-wearing, internal walls in aluminium.

A controlled environment

Electronic control to maintain the required temperature to the nearest 10th of a degree, compressor placed on "silent blocks" to prevent vibration,

polyurethane foam insulant injected into the cabinet body structure in order to ensure a constant temperature.

Peace of *mind*



A relationship of trust & support

Made in France.

Local support with a network of experts in France and abroad.

All EuroCave Professional products have an individual identification number which allows their origin and authenticity to be established.



Access to the contents of your wine cabinet is secured via a lock.

Several visual alarm systems also protect your wine every day: humidity, temperature fault, charcoal filter and temperature sensor fault.

Features

Weight when empty (Kg)

With glass door finish = 92

With solid door finish = 78

Sound emission = 37 dB(A)

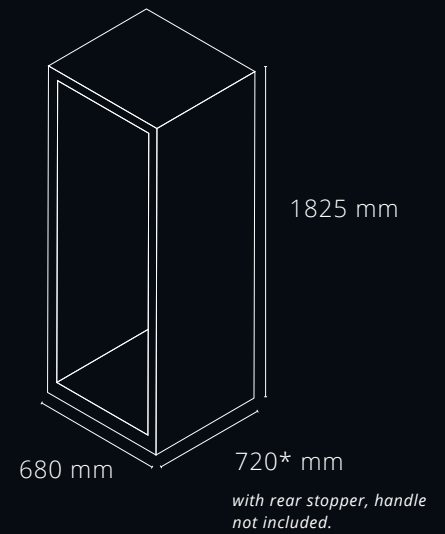
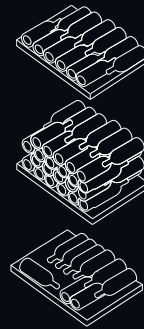

Use

Free-standing

Maturing

Temperature can be set from 6-18°C

Serving

Temperature gradient 5-20°C
At top of cabinet, temperature can be set from 15-20°C
At bottom of cabinet, temperature can be set from 5-10°C

Design

1 size

2 doors

Glass door black frame
Solid door black frame

Stainless steel handle

White lighting for bottles

Equipment

Temperature measured and displayed

Visual alarms:
Humidity, temperature fault, charcoal filter and temperature sensor fault

Adjustable front feet

Lock

Multi-purpose shelf
In beech wood

Aluminium labels to identify your bottles and white marker pen, available as an optional extra